

Article number: 12708000080500

Description: KLEE-coil 708 000 080.500
M8 St. steel 1.4305

Measures

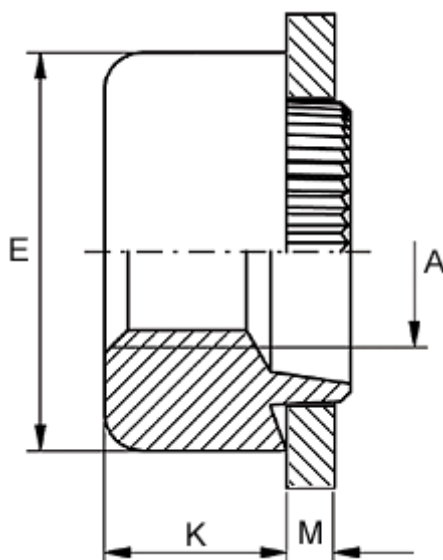

Female thread A	= M8
Height K	= 6.0
Outer diameter E	= 16.0
Plate thickness	= 2.0 to 2.2
Recommended bore diameter for extreme load	= 13.0
Recommended bore diameter for normal use	= 13.0